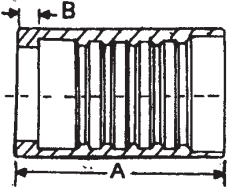
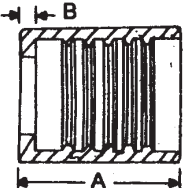
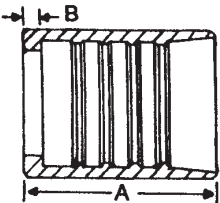
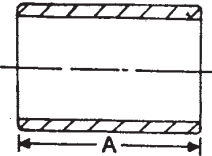
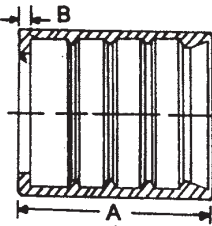
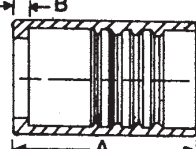
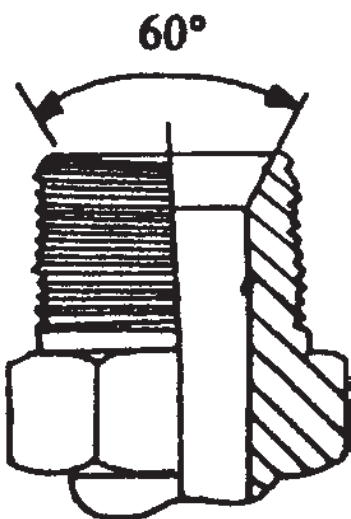
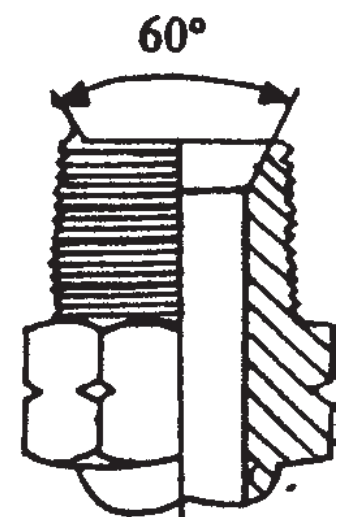
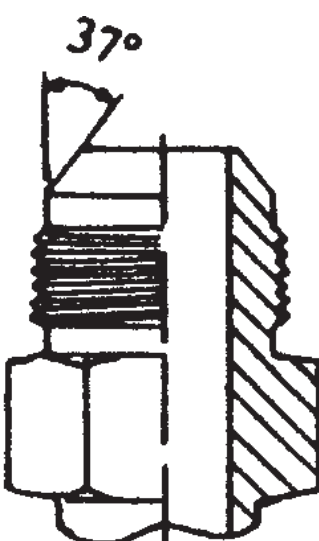

FERRULE SERIES	PRODUCT CODE	O.D. (MM.)	I.D. (MM.)	"A" (MM.)	"B" (MM.)	PRICE /PC.
<p style="text-align: center;">E2A</p> 	E2A-04	21.30	16.20	35.00	3.70	
	E2A-06	23.40	17.80	38.00	3.70	
	E2A-08	28.60	21.80	42.00	3.70	
	E2A-10	31.20	24.40	47.50	4.70	
	E2A-12	35.00	28.40	50.00	4.70	
	E2A-16	44.50	37.00	55.00	4.70	
	E2A-20	55.50	46.40	72.00	5.50	
<p style="text-align: center;">BR</p> 	BR-04	21.30	16.20	25.40	2.00	
	BR-06	23.40	17.80	25.40	2.00	
	BR-08	28.60	21.80	31.60	2.20	
	BR-10	31.20	24.40	31.60	2.20	
	BR-12	35.00	28.40	37.40	2.40	
	BR-16	44.50	37.00	50.00	4.00	
	BR-20	55.50	46.40	70.00	5.00	
<p style="text-align: center;">MS</p> 	MS-04	22.60	16.00	35.00	3.70	
	MS-06	26.90	20.00	38.00	3.70	
	MS-08	32.50	25.00	42.00	3.70	
	MS-10	34.50	26.90	47.50	4.70	
	MS-12	38.00	30.50	50.00	4.70	
	MS-16	47.50	39.40	55.00	4.70	
	MS-20	57.00	48.30	72.00	5.50	
	MS-24	65.00	55.40	74.50	6.40	
	MS-32	80.10	68.40	89.00	6.40	

FERRULE SERIES	PRODUCT CODE	O.D. (MM.)	I.D. (MM.)	"A" (MM.)	"B" (MM.)	PRICE /PC.
<p style="text-align: center;">UK</p> 	UK-04	19.00	16.00	42.00		
	UK-06	24.00	20.00	44.00		
	UK-08	27.00	23.00	47.00		
	UK-10	32.00	28.00	53.00		
	UK-12	37.00	33.00	57.00		
	UK-16	43.00	39.00	64.00		
	UK-20	57.00	51.00	80.00		
<p style="text-align: center;">SS</p> 	SS-12	38.00	31.00	53.00	4.30	
	SS-16	48.00	39.10	58.00	4.50	
	SS-20	61.00	49.80	72.00	4.80	
	SS-24	69.80	58.30	89.00	6.20	
	SS-32	87.00	72.60	93.50	6.20	
<p style="text-align: center;">ISR</p> 	ISR-04	21.70	16.00	40.00	3.50	
	ISR-06	25.40	20.00	42.00	3.50	
	ISR-08	28.60	23.00	45.00	3.50	
	ISR-10	34.00	27.90	52.50	4.70	
	ISR-12	38.00	32.00	56.00	4.70	
	ISR-16	44.50	37.50	63.00	4.70	
	ISR-20	55.50	46.00	80.00	5.00	

GBMT	PRODUCT CODE	HOSE BORE (IN.)	THREAD SIZE (IN.)	PRICE	PRICE 45° / 90°
<p>BSPT MALE PARALLEL 60°</p> 	GBMT-0402	1/4	1/8-28BSPT		
	GBMT-0404	1/4	1/4-19BSPT		
	GBMT-0406	1/4	3/8-19BSPT		
	GBMT-0606	3/8	3/8-19BSPT		
	GBMT-0608	3/8	1/2-14BSPT		
	GBMT-0808	1/2	1/2-14BSPT		
	GBMT-1010	5/8	5/8-14BSPT		
	GBMT-1012	5/8	3/4-14BSPT		
	GBMT-1212	3/4	3/4-14BSPT		
	GBMT-1216	3/4	1-11BSPT		
	GBMT-1616	1	1-11BSPT		
	GBMT-1620	1	1.1/4-11BSPT		
	GBMT-2020	1.1/4	1.1/4-11BSPT		
	GBMT-2024	1.1/4	1.1/2-11BSPT		
	GBMT-2424	1.1/2	1.1/2-11BSPT		
	GBMT-2432	1.1/2	2-11BSPT		
GBMT-3232	2	2-11BSPT			

GPMT	PRODUCT CODE	HOSE BORE (IN.)	THREAD SIZE (IN.)	PRICE	PRICE 45° / 90°
<p>NPT MALE</p> 	GPMT-0402	1/4	1/8-27NPTF		
	GPMT-0404	1/4	1/4-18NPTF		
	GPMT-0406	1/4	3/8-18NPTF		
	GPMT-0606	3/8	3/8-18NPTF		
	GPMT-0608	3/8	1/2-14NPTF		
	GPMT-0808	1/2	1/2-14NPTF		
	GPMT-0810	1/2	5/8-14NPTF		
	GPMT-1012	5/8	3/4-14NPTF		
	GPMT-1212	3/4	3/4-14NPTF		
	GPMT-1216	3/4	1-11.1/2NPTF		
	GPMT-1616	1	1-11.1/2NPTF		
	GPMT-1620	1	1.1/4-11.1/2NPTF		
	GPMT-2020	1.1/4	1.1/4-11.1/2NPTF		
	GPMT-2024	1.1/4	1.1/2-11.1/2NPTF		
	GPMT-2424	1.1/2	1.1/2-11.1/2NPTF		
	GPMT-2432	1.1/2	2-11.1/2NPTF		
GPMT-3232	2	2-11.1/2NPTF			

GJM	PRODUCT CODE	HOSE BORE (IN.)	THREAD SIZE (IN.)	PRICE	PRICE 45° / 90°
<p>JIC MALE 37°</p> 	GJM-0404	1/4	7/16-20UNF		
	GJM-0406	1/4	9/16-18UNF		
	GJM-0606	3/8	9/16-18UNF		
	GJM-0608	3/8	3/4-16UNF		
	GJM-0808	1/2	3/4-16UNF		
	GJM-0810	1/2	7/8-14UNF		
	GJM-1010	5/8	7/8-14UNF		
	GJM-1012	5/8	1.1/16-12UN		
	GJM-1212	3/4	1.1/16-12UN		
	GJM-1216	3/4	1.5/16-12UN		
	GJM-1616	1	1.5/16-12UN		
	GJM-1620	1	1.5/8-12UN		
	GJM-2020	1.1/4	1.5/8-12UN		
	GJM-2024	1.1/4	1.7/8-12UN		
	GJM-2424	1.1/2	1.7/8-12UN		
GJM-2432	1.1/2	2.1/2-12UN			
GJM-3232	2	2.1/2-12UN			

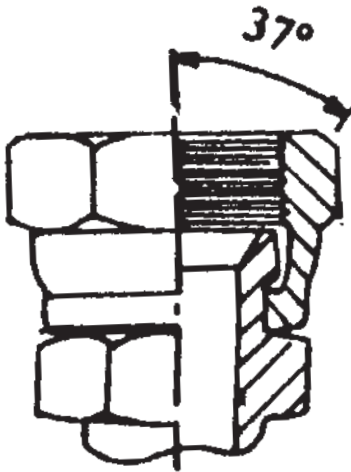
GJS	PRODUCT CODE	HOSE BORE (IN.)	THREAD SIZE (IN.)	PRICE	PRICE 45° / 90°
<p>JIC FEMALE SWIVEL NUT 37°</p> 	GJS-0404	1/4	7/16-20UNF		
	GJS-0406	1/4	9/16-18UNF		
	GJS-0606	3/8	9/16-18UNF		
	GJS-0608	3/8	3/4-16UNF		
	GJS-0808	1/2	3/4-16UNF		
	GJS-0810	1/2	7/8-14UNF		
	GJS-1010	5/8	7/8-14UNF		
	GJS-1012	5/8	1.1/16-12UN		
	GJS-1212	3/4	1.1/16-12UN		
	GJS-1216	3/4	1.5/16-12UN		
	GJS-1616	1	1.5/16-12UN		
	GJS-1620	1	1.5/8-12UN		
	GJS-2020	1.1/4	1.5/8-12UN		
	GJS-2024	1.1/4	1.7/8-12UN		
	GJS-2424	1.1/2	1.7/8-12UN		
GJS-2432	1.1/2	2.1/2-12UN			
GJS-3232	2	2.1/2-12UN			

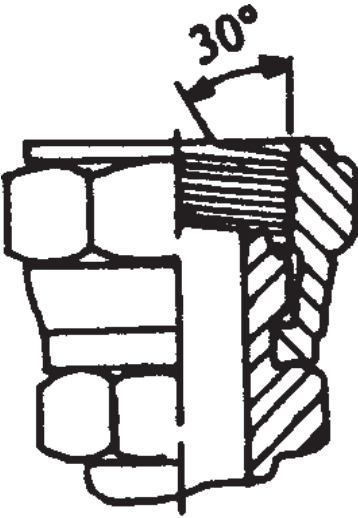
GBS	PRODUCT CODE	HOSE BORE (IN.)	THREAD SIZE (IN.)	PRICE	PRICE 45° / 90°
<p>BSPP FEMALE SWIVEL NUT 30°</p>  <p>เตเปอร์นูน</p>	GBS-0404	1/4	P.F. 1/4-19		
	GBS-0406	1/4	P.F. 3/8-19		
	GBS-0606	3/8	P.F. 3/8-19		
	GBS-0608	3/8	P.F. 1/2-14		
	GBS-0808	1/2	P.F. 1/2-14		
	GBS-0810	1/2	P.F. 5/8-14		
	GBS-1010	5/8	P.F. 5/8-14		
	GBS-1012	5/8	P.F. 3/4-14		
	GBS-1212	3/4	P.F. 3/4-14		
	GBS-1216	3/4	P.F. 1-11		
	GBS-1616	1	P.F. 1-11		
	GBS-1620	1	P.F. 1.1/4-11		
	GBS-2020	1.1/4	P.F. 1.1/4-11		
	GBS-2024	1.1/4	P.F. 1.1/2-11		
	GBS-2424	1.1/2	P.F. 1.1/2-11		
	GBS-2432	1.1/2	P.F. 2-11		
GBS-3232	2	P.F. 2-11			

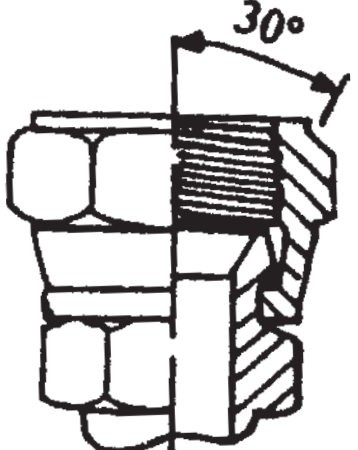
GBFS	PRODUCT CODE	HOSE BORE (IN.)	THREAD SIZE (IN.)	PRICE	PRICE 45° / 90°
<p>BSPP FEMALE INVERTED CONE SWIVEL NUT</p>  <p>เตเปอร์เว้า</p>	GBFS-0402	1/4	P.F. 1/8-28		
	GBFS-0404	1/4	P.F. 1/4-19		
	GBFS-0406	1/4	P.F. 3/8-19		
	GBFS-0606	3/8	P.F. 3/8-19		
	GBFS-0608	3/8	P.F. 1/2-14		
	GBFS-0808	1/2	P.F. 1/2-14		
	GBFS-0810	1/2	P.F. 5/8-14		
	GBFS-1010	5/8	P.F. 5/8-14		
	GBFS-1012	5/8	P.F. 3/4-14		
	GBFS-1212	3/4	P.F. 3/4-14		
	GBFS-1216	3/4	P.F. 1-11		
	GBFS-1616	1	P.F. 1-11		
	GBFS-1620	1	P.F. 1.1/4-11		
	GBFS-2020	1.1/4	P.F. 1.1/4-11		
	GBFS-2024	1.1/4	P.F. 1.1/2-11		
	GBFS-2424	1.1/2	P.F. 1.1/2-11		
GBFS-3232	2	P.F. 2-11			

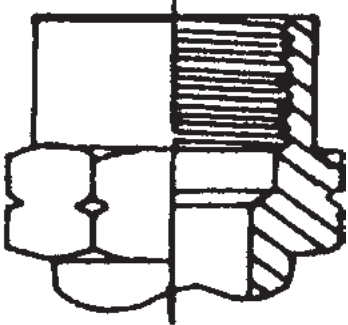
GPNT	PRODUCT CODE	HOSE BORE (IN.)	THREAD SIZE (IN.)	PRICE	PRICE 45° / 90°	
<p>NPT FEMALE TAPPED HOLE</p> 	GPNT-0402	1/4	1/8-27NPTF			
	GPNT-0404	1/4	1/4-18NPTF			
	GPNT-0406	1/4	3/8-18NPTF			
	GPNT-0606	3/8	3/8-18NPTF			
	GPNT-0608	3/8	1/2-14NPTF			
	GPNT-0808	1/2	1/2-14NPTF			
	GPNT-1012	5/8	3/4-14NPTF			
	GPNT-1212	3/4	3/4-14NPTF			

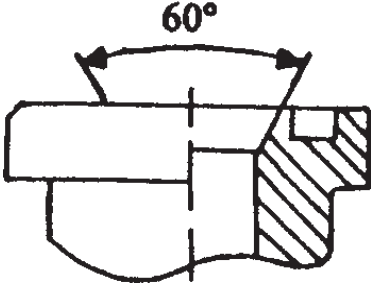
GSA	PRODUCT CODE	HOSE BORE (IN.)	THREAD SIZE (IN.)	PRICE	PRICE 45° / 90°	
<p>SAE O'RING FLANGE CODE 61</p> 	GSA-0606	3/8	R 3/4			
	GSA-0608	3/8	R 1.3/16			
	GSA-0808	1/2	R 1.3/16			
	GSA-0810	1/2	R 1.11/32			
	GSA-1010	5/8	R 1.11/32			
	GSA-1012	5/8	R 1.1/2			
	GSA-1212	3/4	R 1.1/2			
	GSA-1216	3/4	R 1.3/4			
	GSA-1616	1	R 1.3/4			
	GSA-1620	1	R 2			
	GSA-2020	1.1/4	R 2			
	GSA-2024	1.1/4	R 2.3/8			
	GSA-2424	1.1/2	R 2.3/8			
	GSA-2432	1.1/2	R 2.13/16			
	GSA-3232	2	R 2.13/16			

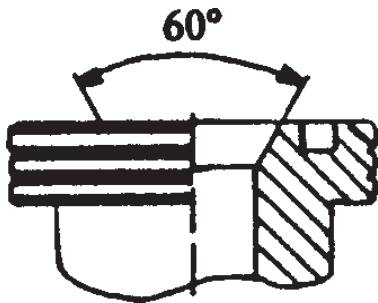
GSAH	PRODUCT CODE	HOSE BORE (IN.)	THREAD SIZE (IN.)	PRICE	PRICE 45° / 90°
SAE O'RING FLANGE CODE 62 	GSAH-0608	3/8	R 1.1/4		
	GSAH-0808	1/2	R 1.1/4		
	GSAH-1012	5/8	R 1.5/8		
	GSAH-1212	3/4	R 1.5/8		
	GSAH-1216	3/4	R 1.7/8		
	GSAH-1616	1	R 1.7/8		
	GSAH-1620	1	R 2.1/8		
	GSAH-2020	1.1/4	R 2.1/8		
	GSAH-2024	1.1/4	R 2.1/2		
	GSAH-2424	1.1/2	R 2.1/2		
	GSAH-2432	1.1/2	R 3.1/8		
	GSAH-3232	2	R 3.1/8		

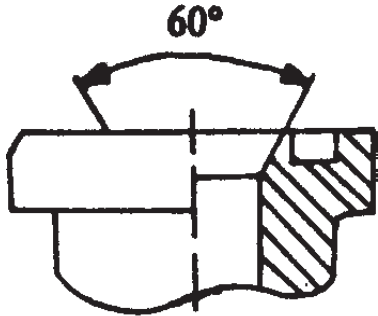
GSAC	PRODUCT CODE	HOSE BORE (IN.)	THREAD SIZE (IN.)	PRICE	PRICE 45° / 90°
EHP O'RING FLANGE "CAT" STYLE 	GSAC-1212	3/4	R 1.5/8-1/2		
	GSAC-1216	3/4	R 1.7/8-1/2		
	GSAC-1616	1	R 1.7/8-1/2		
	GSAC-1620	1	R 2.1/8-1/2		
	GSAC-2020	1.1/4	R 2.1/8-1/2		
	GSAC-2024	1.1/4	R 2.1/2-1/2		
	GSAC-2424	1.1/2	R 2.1/2-1/2		
	GSAC-2432	1.1/2	R 3.1/8-1/2		
	GSAC-3232	2	R 3.1/8-1/2		

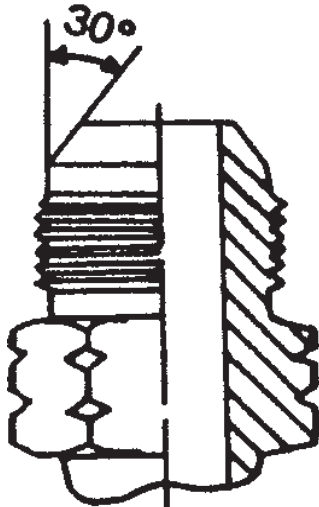
GKM	PRODUCT CODE	HOSE BORE (IN.)	THREAD SIZE (IN.)	PRICE	PRICE 45° / 90°	
METRIC MALE KOMATSU 	GKM-0414	1/4	M 14x1.5			
	GKM-0618	3/8	M 18x1.5			
	GKM-0822	1/2	M 22x1.5			
	GKM-1024	5/8	M 24x1.5			
	GKM-1230	3/4	M 30x1.5			
	GKM-1633	1	M 33x1.5			
	GKM-2036	1.1/4	M 36x1.5			
	GKM-2442	1.1/2	M 42x1.5			

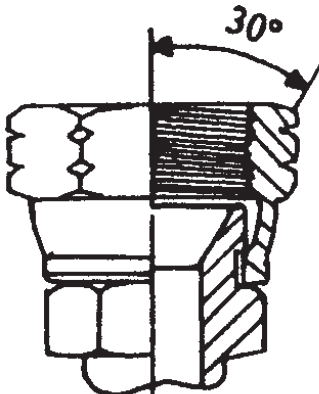
GKS	PRODUCT CODE	HOSE BORE (IN.)	THREAD SIZE (IN.)	PRICE	PRICE 45° / 90°	
METRIC FEMALE KOMATSU SWIVEL NUT 30° FLARE 	GKS-0414	1/4	M 14x1.5			
	GKS-0418	1/4	M 18x1.5			
	GKS-0618	3/8	M 18x1.5			
	GKS-0622	3/8	M 22x1.5			
	GKS-0822	1/2	M 22x1.5			
	GKS-0824	1/2	M 24x1.5			
	GKS-1024	5/8	M 24x1.5			
	GKS-1030	5/8	M 30x1.5			
	GKS-1230	3/4	M 30x1.5			
	GKS-1233	3/4	M 33x1.5			
	GKS-1633	1	M 33x1.5			
	GKS-1636	1	M 36x1.5			
	GKS-2036	1.1/4	M 36x1.5			
	GKS-2042	1.1/4	M 42x1.5			
	GKS-2442	1.1/2	M 42x1.5			

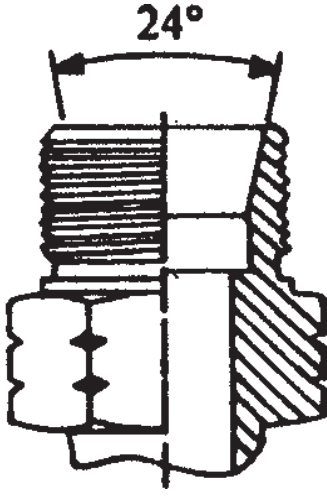
GVHM	PRODUCT CODE	HOSE BORE (IN.)	THREAD SIZE (IN.)	PRICE	PRICE 45° / 90°
METRIC MALE HEAVY DIN 3902 	GVHM-0414	1/4	M 14x1.5 P6		
	GVHM-0416	1/4	M 16x1.5 P8		
	GVHM-0418	1/4	M 18x1.5 P10		
	GVHM-0616	3/8	M 16x1.5 P8		
	GVHM-0620	3/8	M 20x1.5 P12		
	GVHM-0622	3/8	M 22x1.5 P15		
	GVHM-0822	1/2	M 22x1.5 P15		
	GVHM-0824	1/2	M 24x1.5 P16		
	GVHM-1024	5/8	M 24x1.5 P16		
	GVHM-1030	5/8	M 30x2.0 P20		
	GVHM-1230	3/4	M 30x2.0 P20		
	GVHM-1236	3/4	M 36x2.0 P25		
	GVHM-1642	1	M 42x2.0 P30		
	GVHM-2052	1.1/4	M 52x2.0 P38		

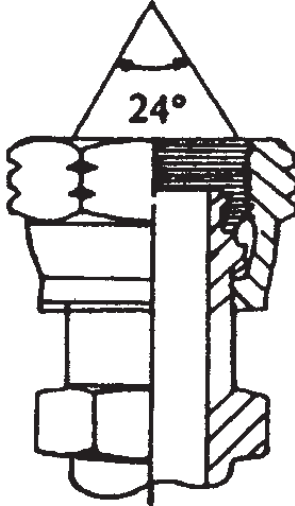
GVHOS	PRODUCT CODE	HOSE BORE (IN.)	THREAD SIZE (IN.)	PRICE	PRICE 45° / 90°
METRIC FEMALE DIN HEAVY O'RING 	GVHOS-0414	1/4	M 14x1.5 P6		
	GVHOS-0416	1/4	M 16x1.5 P8		
	GVHOS-0418	1/4	M 18x1.5 P10		
	GVHOS-0616	3/8	M 16x1.5 P8		
	GVHOS-0620	3/8	M 20x1.5 P12		
	GVHOS-0622	3/8	M 22x1.5 P15		
	GVHOS-0822	1/2	M 22x1.5 P15		
	GVHOS-0824	1/2	M 24x1.5 P16		
	GVHOS-1024	5/8	M 24x1.5 P16		
	GVHOS-1030	5/8	M 30x2.0 P20		
	GVHOS-1230	3/4	M 30x2.0 P20		
	GVHOS-1236	3/4	M 36x2.0 P25		
	GVHOS-1642	1	M 42x2.0 P30		
	GVHOS-2052	1.1/4	M 52x2.0 P38		

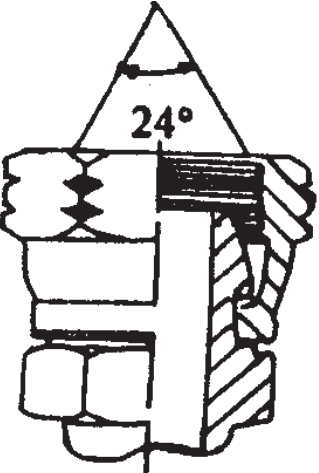
GZIS	PRODUCT CODE	HOSE BORE (IN.)	THREAD SIZE (IN.)	PRICE	PRICE 45° / 90°
METRIC FEMALE ISO SWIVEL NUT 	GZIS-0414	1/4	M 14x1.5		
	GZIS-0416	1/4	M 16x1.5		
	GZIS-0616	3/8	M 16x1.5		
	GZIS-0618	3/8	M 18x1.5		
	GZIS-0620	3/8	M 20x1.5		
	GZIS-0622	3/8	M 22x1.5		
	GZIS-0820	1/2	M 20x1.5		
	GZIS-0822	1/2	M 22x1.5		
	GZIS-0824	1/2	M 24x1.5		
	GZIS-1024	5/8	M 24x1.5		
	GZIS-1027	5/8	M 27x1.5		
	GZIS-1230	3/4	M 30x1.5		
	GZIS-1233	3/4	M 33x1.5		
	GZIS-1633	1	M 33x1.5		
	GZIS-1636	1	M 36x1.5		
GZIS-1639	1	M 39x1.5			

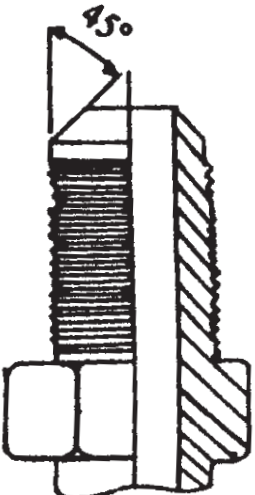
GKME	PRODUCT CODE	HOSE BORE (IN.)	THREAD SIZE (IN.)	PRICE	PRICE 45° / 90°
METRIC EXTENDED MALE 	GKME-0410	1/4	M 10x1.0		
	GKME-0412	1/4	M 12x1.0		
	GKME-0412	1/4	M 12x1.5		
	GKME-0414	1/4	M 14x1.5		
	GKME-0616	3/8	M 16x1.5		
	GKME-0618	3/8	M 18x1.5		
	GKME-0620	3/8	M 20x1.5		
	GKME-0622	3/8	M 22x1.5		
	GKME-0816	1/2	M 16x1.5		
	GKME-0818	1/2	M 18x1.5		
	GKME-0820	1/2	M 20x1.5		
	GKME-0822	1/2	M 22x1.5		

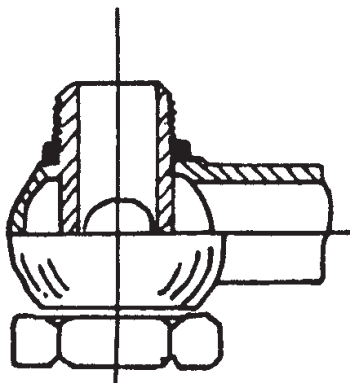
GBJB	PRODUCT CODE	HOSE BORE (IN.)	THREAD SIZE (IN.)	PRICE	PRICE 45° / 90°	
BSP BANJO 	GBJB-0404	1/4	G 1/4B-19			
	GBJB-0606	3/8	G 3/8B-19			
	GBJB-0808	1/2	G 1/2B-14			
	GBJB-1010	5/8	G 5/8B-14			
	GBJB-1212	3/4	G 3/4B-14			
	GBJB-1616	1	G 1B-11			

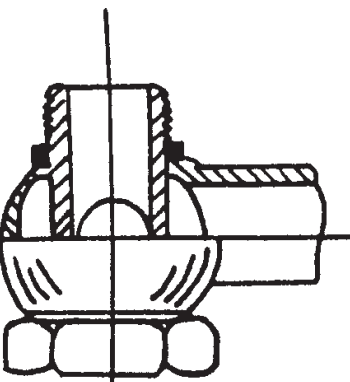
GBJM	PRODUCT CODE	HOSE BORE (IN.)	THREAD SIZE (IN.)	PRICE	PRICE 45° / 90°	
BANJO PARALLEL DIN 7642 	GBJM-0412	1/4	M 12x1.5			
	GBJM-0614	3/8	M 14x1.5			
	GBJM-0616	3/8	M 16x1.5			
	GBJM-0618	3/8	M 18x1.5			
	GBJM-0818	1/2	M 18x1.5			
	GBJM-0822	1/2	M 22x1.5			
	GBJM-1022	5/8	M 22x1.5			
	GBJM-1226	3/4	M 26x1.5			